

DUO CONNECTOR STOOLS

Chairs & Stools

General Specifications

Seat: Fully upholstered seat cushion comprised of 4" high density foam.





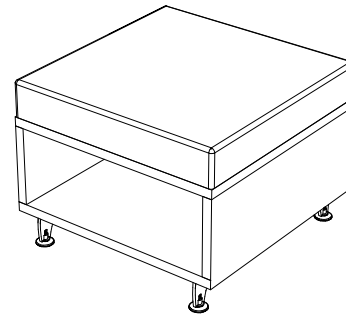

Base Assembly: The base assembly is fabricated from 1" thick engineered wood with high-pressure laminate faces and 3mm PVC edges or premium grade oak or maple veneer faces with 3mm wood edges.

Leg Assemblies: Legs are fabricated from 5/16" plate steel and include a curved profile with a square mounting plate. The bottom of each leg is fitted with a threaded weld nut and 1-7/8" black leveling glide.

Finish: See www.mediatechnologies.com/products/fabric/Seating for fabric choices and **mediatechnologies®** Finish and Color Guide for additional finish choices.



Duo Connector Stool

Model Number	Base Type	Base Enclosure	Finish	Seat	Seat Hgt.	COM Yd.	List Price								
							Grade 1 COM	Grade 2	Grade 3	Grade 4	Grade 5	Grade 6	Grade 7	Grade 8	Grade 9
Rectangle Stool															
 DUC-2418-USO-18	Post	Open	Veneer	Uph	18"	1	\$1,400	\$1,445	\$1,489	\$1,535	\$1,577	\$1,623	\$1,670	\$1,719	\$1,771
DUC-2418-USOL-18	Post	Open	HPL	Uph	18"	1	\$1,178	\$1,217	\$1,253	\$1,292	\$1,329	\$1,366	\$1,404	\$1,443	\$1,484
DUC-2418-USO-25	Post	Open	Veneer	Uph	25"	1	\$1,495	\$1,542	\$1,586	\$1,629	\$1,672	\$1,716	\$1,763	\$1,811	\$1,862
DUC-2418-USOL-25	Post	Open	HPL	Uph	25"	1	\$1,258	\$1,297	\$1,335	\$1,373	\$1,408	\$1,445	\$1,483	\$1,522	\$1,562
 DUC-2418-USC-18	Post	Closed	Veneer	Uph	18"	1	\$1,457	\$1,500	\$1,547	\$1,592	\$1,635	\$1,679	\$1,726	\$1,774	\$1,825
DUC-2418-USCL-18	Post	Closed	HPL	Uph	18"	1	\$1,227	\$1,263	\$1,302	\$1,339	\$1,377	\$1,414	\$1,452	\$1,491	\$1,531
DUC-2418-USC-25	Post	Closed	Veneer	Uph	25"	1	\$1,554	\$1,599	\$1,644	\$1,689	\$1,732	\$1,777	\$1,825	\$1,874	\$1,926
DUC-2418-USCL-25	Post	Closed	HPL	Uph	25"	1	\$1,308	\$1,347	\$1,384	\$1,420	\$1,458	\$1,496	\$1,535	\$1,575	\$1,616
Square Stool															
 DUC-2424-USO-18	Post	Open	Veneer	Uph	18"	1	\$1,544	\$1,590	\$1,632	\$1,677	\$1,724	\$1,767	\$1,812	\$1,859	\$1,909
DUC-2424-USOL-18	Post	Open	HPL	Uph	18"	1	\$1,299	\$1,337	\$1,375	\$1,412	\$1,450	\$1,488	\$1,527	\$1,567	\$1,608
DUC-2424-USO-25	Post	Open	Veneer	Uph	25"	1	\$1,644	\$1,684	\$1,729	\$1,773	\$1,820	\$1,869	\$1,919	\$1,972	\$2,027
DUC-2424-USOL-25	Post	Open	HPL	Uph	25"	1	\$1,384	\$1,417	\$1,456	\$1,493	\$1,534	\$1,573	\$1,613	\$1,654	\$1,696
 DUC-2424-USC-18	Post	Closed	Veneer	Uph	18"	1	\$1,602	\$1,647	\$1,691	\$1,735	\$1,780	\$1,825	\$1,871	\$1,919	\$1,970
DUC-2424-USCL-18	Post	Closed	HPL	Uph	18"	1	\$1,349	\$1,386	\$1,424	\$1,462	\$1,498	\$1,537	\$1,577	\$1,618	\$1,662
DUC-2424-USC-25	Post	Closed	Veneer	Uph	25"	1	\$1,698	\$1,743	\$1,788	\$1,832	\$1,879	\$1,929	\$1,980	\$2,034	\$2,090
DUC-2424-USCL-25	Post	Closed	HPL	Uph	25"	1	\$1,430	\$1,467	\$1,505	\$1,543	\$1,583	\$1,624	\$1,667	\$1,712	\$1,759
45 Degree Wedge Stool															
 DUC-2420-USCR45-18	Post	Closed	Veneer	Uph	18"	1	\$2,036	\$2,082	\$2,126	\$2,171	\$2,216	\$2,259	\$2,304	\$2,349	\$2,395
DUC-2420-USCR45L-18	Post	Closed	HPL	Uph	18"	1	\$1,714	\$1,753	\$1,789	\$1,827	\$1,866	\$1,903	\$1,940	\$1,979	\$2,019
DUC-2420-USCR45-25	Post	Closed	Veneer	Uph	25"	1	\$2,093	\$2,138	\$2,183	\$2,228	\$2,254	\$2,344	\$2,437	\$2,535	\$2,637
DUC-2420-USCR45L-25	Post	Closed	HPL	Uph	25"	1	\$1,763	\$1,800	\$1,837	\$1,875	\$1,924	\$1,973	\$2,025	\$2,078	\$2,134
 DUC-2420-USCFR45-18	Post	Closed	Veneer	Uph	18"	1	\$2,036	\$2,082	\$2,126	\$2,171	\$2,216	\$2,259	\$2,304	\$2,349	\$2,395
DUC-2420-USCFR45L-18	Post	Closed	HPL	Uph	18"	1	\$1,714	\$1,753	\$1,789	\$1,827	\$1,866	\$1,903	\$1,940	\$1,979	\$2,019
DUC-2420-USCFR45-25	Post	Closed	Veneer	Uph	25"	1	\$2,093	\$2,138	\$2,183	\$2,228	\$2,254	\$2,344	\$2,437	\$2,535	\$2,637
DUC-2420-USCFR45L-25	Post	Closed	HPL	Uph	25"	1	\$1,763	\$1,800	\$1,837	\$1,875	\$1,924	\$1,973	\$2,025	\$2,078	\$2,134

Required to order:

- Model # including:
- wood selection and wood finish (if applicable)
 - HPL selection and PVC selection (if applicable)
 - fabric selection
 - powder coat selection

Note:

Veneer prices listed above are for an oak construction. Seats constructed of maple or other materials may incur an upcharge

DUO CONNECTOR STOOLS

Chairs & Stools

Duo Connector Stool

Model Number	Base Type	Base Enclosure	Finish	Seat	Seat Hgt.	COM Yd.	List Price									
							Grade 1 COM	Grade 2	Grade 3	Grade 4	Grade 5	Grade 6	Grade 7	Grade 8	Grade 9	
 DUC-2436-USOR45-18	Post	Open	Veneer	Uph	18"	1	\$1,883	\$1,927	\$1,972	\$2,017	\$2,062	\$2,108	\$2,155	\$2,205	\$2,256	
DUC-2436-USOR4L5-18	Post	Open	HPL	Uph	18"	1	\$1,585	\$1,623	\$1,659	\$1,698	\$1,735	\$1,773	\$1,812	\$1,852	\$1,893	
DUC-2436-USOR45-25	Post	Open	Veneer	Uph	25"	1	\$1,938	\$1,982	\$2,027	\$2,073	\$2,126	\$2,171	\$2,217	\$2,265	\$2,313	
DUC-2436-USOR45L-25	Post	Open	HPL	Uph	25"	1	\$1,631	\$1,669	\$1,707	\$1,745	\$1,789	\$1,836	\$1,886	\$1,937	\$1,991	
90 Degree Wedge																
 DUC-2435-USCR90-18	Post	Closed	Veneer	Uph	18"	1	\$2,048	\$2,093	\$2,138	\$2,183	\$2,228	\$2,273	\$2,319	\$2,367	\$2,415	
DUC-2435-USCR90L-18	Post	Closed	HPL	Uph	18"	1	\$1,725	\$1,763	\$1,800	\$1,837	\$1,875	\$1,914	\$1,954	\$1,995	\$2,037	
DUC-2435-USCR90-25	Post	Closed	Veneer	Uph	25"	1	\$2,133	\$2,178	\$2,223	\$2,268	\$2,327	\$2,386	\$2,447	\$2,510	\$2,575	
DUC-2435-USCR90L-25	Post	Closed	HPL	Uph	25"	1	\$1,796	\$1,833	\$1,871	\$1,910	\$1,958	\$2,009	\$2,062	\$2,116	\$2,173	
 DUC-2452-USOR90-18	Post	Open	Veneer	Uph	18"	1.5	\$2,733	\$2,799	\$2,864	\$2,930	\$2,994	\$3,198	\$3,417	\$3,652	\$3,904	
DUC-2452-USOR90L-18	Post	Open	HPL	Uph	18"	1.5	\$2,302	\$2,356	\$2,410	\$2,466	\$2,520	\$2,693	\$2,878	\$3,077	\$3,291	
DUC-2452-USOR90-25	Post	Open	Veneer	Uph	25"	1.5	\$2,873	\$2,938	\$3,003	\$3,070	\$3,149	\$3,229	\$3,311	\$3,395	\$3,483	
DUC-2452-USOR90L-25	Post	Open	HPL	Uph	25"	1.5	\$2,419	\$2,474	\$2,529	\$2,585	\$2,651	\$2,718	\$2,788	\$2,859	\$2,933	

Required to order:

Model # including:

- wood selection and wood finish (if applicable)
- HPL selection and PVC selection (if applicable)
- fabric selection
- powder coat selection

Note:

Veneer prices listed above are for an oak construction. Seats constructed of maple or other materials may incur an upcharge